



Features

- Output Current of 500mA
- Output transistor safe area protection
- No external components
- Package: TO252

General Description

HL78MXX is three-terminal positive regulators. One of these regulators can deliver up to 1A of output current. When used as a replacement for a

Zener diode-resistor Combination, an effective improvement in output impedance can be obtained, together with lower quiescent current.

Pin Configuration

TO252 (Top View)

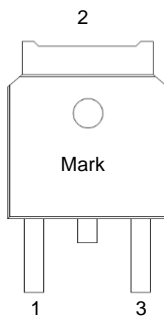

PIN NO.	PIN NAME	FUNCTION
1	VIN	Input voltage pin
2	GND	Ground pin
3	VOUT	Output voltage pin

Block Diagram

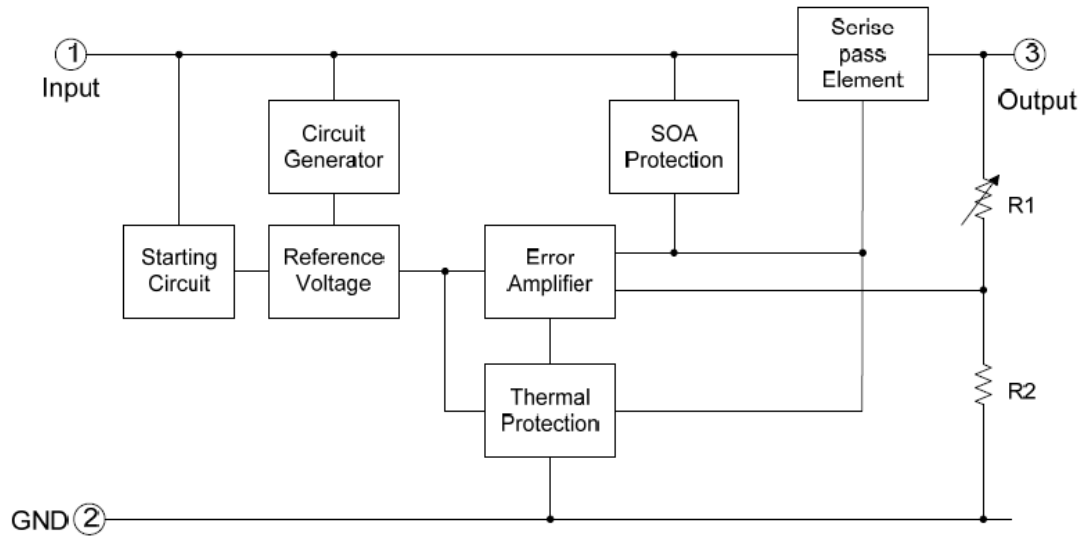

Absolute Maximum Ratings (Ta=25°C)

Parameter	Rating	Unit
Input supply voltage: VIN	35	V
MAX. Output current: Iout	1000	mA
MAX Power: Pmax	0.35	W
Maximum junction temperature: Tj	-25~125	°C
Storage temperature: Tstr	-55~125	°C
Soldering temperature and time	+260(Recommended 10S)	°C

Note: The absolute maximum ratings are rated values exceeding which the product could suffer physical damage. These values must therefore not be exceeded under any conditions.



Electrical Characteristics

(C_{in}=0.33uF, C_o=0.1uF, 0 ≤ T_j ≤ 125°C, unless otherwise noted)

Parameter	Symbol	Conditions	Min.	Typ.	Max.	Unit
Output Voltage	V _{out}	I _o =40mA, V _{IN} =10V	0.964v _{out}	v _{out}	1.036v _{out}	V
		I _o =1mA~40mA V _{IN} =7V~18V	0.96v _{out}	v _{out}	1.04v _{out}	
		I _o =10mA V _{IN} =10V	0.95v _{out}	v _{out}	1.05v _{out}	
Line Regulation	LNR	V _{IN} =7V~18V, I _o =40mA	-150	-	150	mV
		V _{IN} =8V~18V, I _o =40mA	-100	-	100	
Load Regulation	LDR	V _{IN} =10V, I _o =1mA~100mA	-60	-	60	mV
		V _{IN} =10V, I _o =1mA~40mA	-30	-	30	
Dropout Voltage	V _{DIF}	T _j =25°C, I _o =500mA	-	1.7	-	V
Quiescent Current	I _q	V _{IN} =10V	-	1.5	--	mA
Quiescent Current Change	ΔI _q	V _{IN} =8V~18V, I _o =40mA	-1.5	-	1.5	mA
		V _{IN} =10V, I _O UT=1mA~40mA,	-0.1	-	0.1	

LNR: Line Regulation. The change in output voltage for a change in the input voltage. The measurement is made under conditions of low dissipation or by using pulse techniques such that the average chip temperature is not significantly affected.

LDR: Load Regulation. The change in output voltage for a change in load current at constant chip temperature.

Typical Performance Characteristics

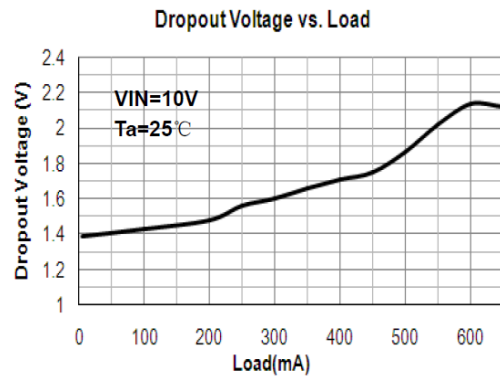
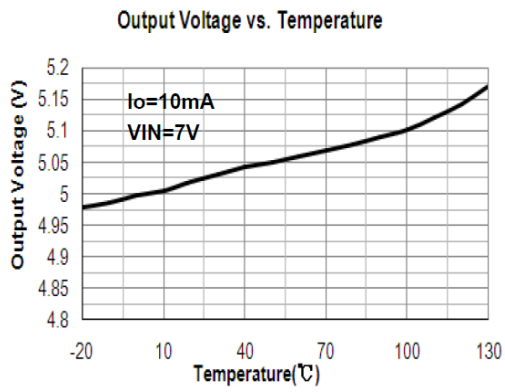
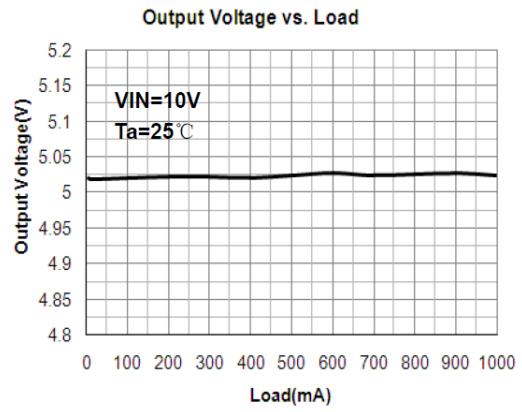
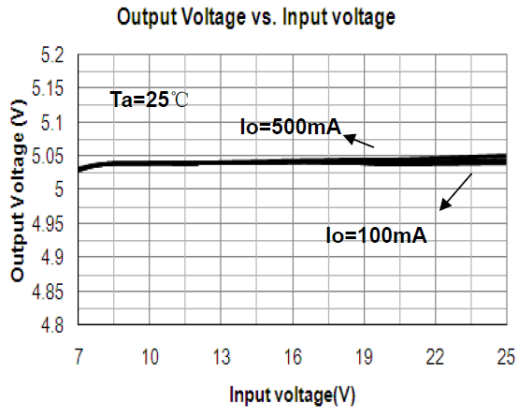

Operation Description

HL78MXX is three-terminal positive regulators. One of these regulators can deliver up to 1A of output current. In many low current applications, compensation capacitors are not required. However, it is recommended that the regulator input be bypassed with a capacitor if the regulator is connected to the power supply filter with long wire lengths, or if the output load capacitance is large. An input bypass capacitor should be selected to provide good high frequency characteristics to insure stable operation under all load conditions. A 0.33μF tantalum, or other capacitor having low internal impedance at high frequencies should be chosen. The bypass capacitor should be mounted with the shortest possible leads directly across the regulator's input terminals. Normally good construction techniques should be used to minimize ground loops and lead resistance drops since the regulator has no external sense lead.

Typical Application

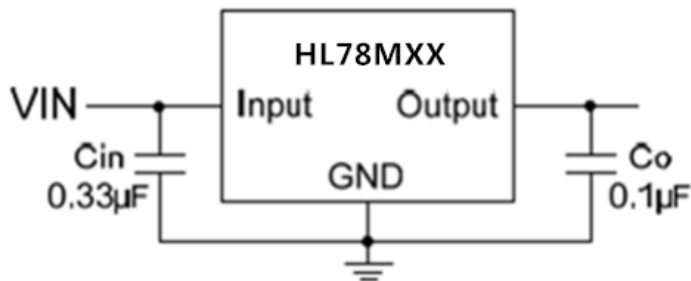

Fig.1 Fixed Output Regulator

A common ground is required between the input and the output voltages. The input voltage must remain typically 2.0 V above the output voltage even during the low point on the input ripple voltage.

- Cin is required if regulator is located an appreciable distance from power supply filter.
- Co is not needed for stability; however, it does improve transient response.

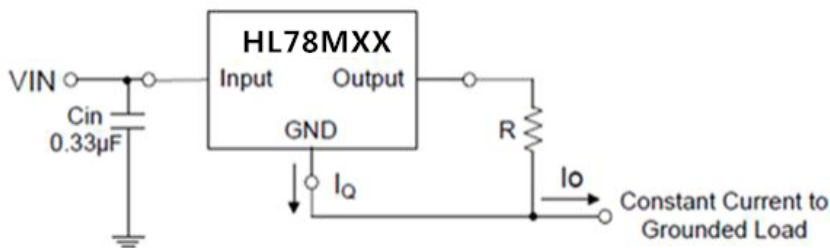

Fig.2 Constant Current Regulator

The HL78MXX regulator can also be used as a current source when connected as Fig.2. In order to minimize dissipation the HL78XX is chosen in this application. Resistor R determines the current as

follows:

$$I_o = \frac{5V}{R} + I_q$$

Package Information

TO-252-2L PACKAGE OUTLINE DIMENSIONS

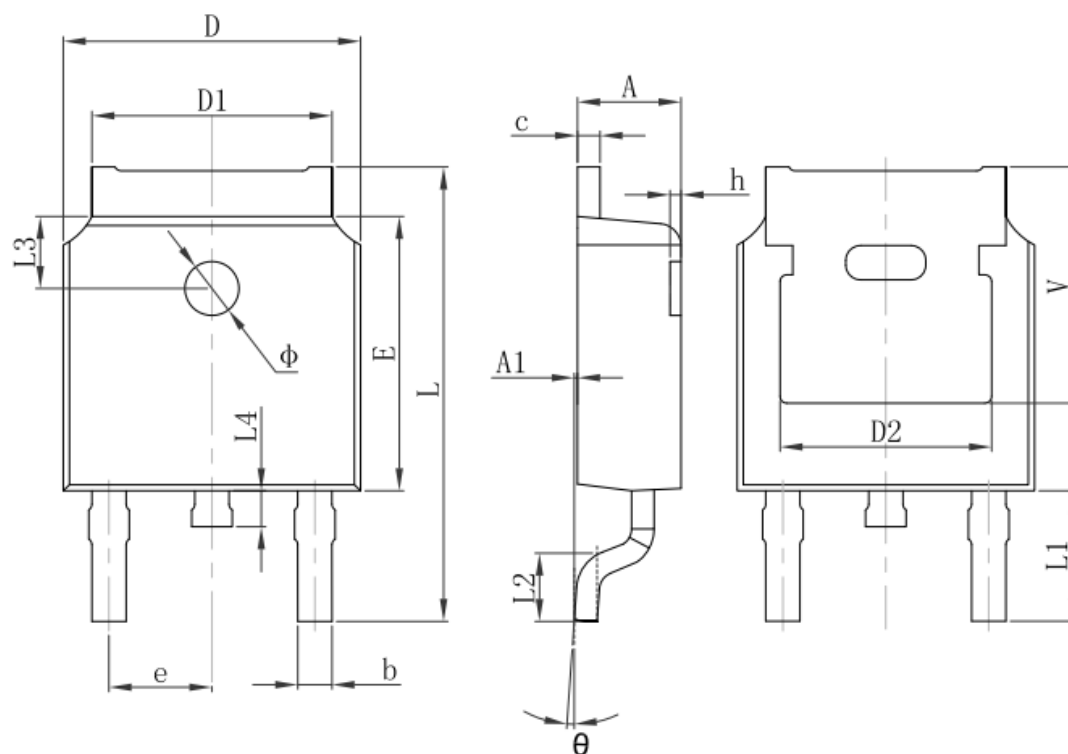

Symbol	Dimensions In Millimeters		Dimensions In Inches	
	Min.	Max.	Min.	Max.
A	2.200	2.400	0.087	0.094
A1	0.000	0.127	0.000	0.005
b	0.660	0.860	0.026	0.034
c	0.460	0.580	0.018	0.023
D	6.500	6.700	0.256	0.264
D1	5.100	5.460	0.201	0.215
D2	4.830 REF.		0.190 REF.	
E	6.000	6.200	0.236	0.244
e	2.186	2.386	0.086	0.094
L	9.800	10.400	0.386	0.409
L1	2.900 REF.		0.114 REF.	
L2	1.400	1.700	0.055	0.067
L3	1.600 REF.		0.063 REF.	
L4	0.600	1.000	0.024	0.039
Φ	1.100	1.300	0.043	0.051
θ	0°	8°	0°	8°
h	0.000	0.300	0.000	0.012
V	5.350 REF.		0.211 REF.	