



# HL9710L

2.5A, High Efficiency  
1.2MHz Current Mode Step-Up Converter

## FEATURES

- Integrated 80mΩ Power MOSFET
- 2.2V to 16V Input Voltage
- 1.2MHz Fixed Switching Frequency
- Adjustable Over Current Protection: 0.5A ~2.5A
- Internal 2.5A Switch Current Limit(OC pin floating)
- Adjustable Output Voltage
- Internal Compensation
- Over Voltage Protection
- Up to 20V Output Voltage
- Automatic Pulse Frequency Modulation Mode at Light Loads
- up to 93% Efficiency
- Available in a 6-Pin SOT23-6 Package

## GENERAL DESCRIPTION

The HL9710L is a constant frequency, 6-pin SOT23 current mode step-up converter intended for small, low power applications. The HL9710L switches at 1.2MHz and allows the use of tiny, low cost capacitors and inductors 2mm or less in height. Internal soft-start results in small inrush current and extends battery life.

The HL9710L features automatic shifting to pulse frequency modulation mode at light loads. The HL9710L includes under-voltage lockout, current limiting, and thermal overload protection to prevent damage in the event of an output overload. The HL9710L is available in a small 6-pin SOT-23

## APPLICATIONS

- Battery-Powered Equipment
- Set-Top Boxed
- LCD Bias Supply
- DSL and Cable Modems and Routers
- Networking cards powered from PCI or PCI express slots

## TYPICAL APPLICATION

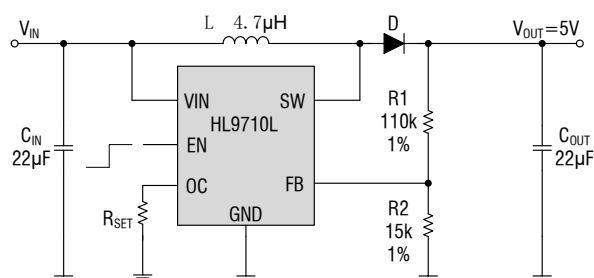
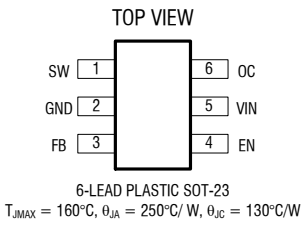

Figure 1. Basic Application Circuit

## ABSOLUTE MAXIMUM RATINGS (Note 1)

VIN, EN voltages.....	-0.3V to 18V	Junction Temperature(Note2).....	160°C
FB, Voltages.....	-0.3V to 6V	Operating Temperature Range.....	-40°C to 85°C
SW Voltage.....	-0.3V to 22V	Lead Temperature(Soldering, 10s).....	300°C
Power Dissipation.....	0.6W	Storage Temperature Range.....	-65°C to 150°C
Thermal Resistance $\theta_{JC}$ .....	130°C/W	ESD HBM(Human Body Mode).....	2kV
Thermal Resistance $\theta_{JA}$ .....	250°C/W	ESD MM(Machine Mode).....	200V

## PACKAGE / ORDER INFORMATION

	Order Part Number	Package	Top Marking
	HL9710L	SOT23-6	B628

## PIN DESCRIPTION

Pin Name	Pin Number	Description
SW	1	Power Switch Output. SW is the drain of the internal MOSFET switch. Connect the power inductor and output rectifier to SW. SW can swing between GND and 22V.
GND	2	Ground Pin
FB	3	Feedback Input. The FB voltage is 0.6V. Connect a resistor divider to FB.
EN	4	Regulator On/Off Control Input. A high input at EN turns on the converter, and a low input turns it off. When not used, connect EN to the input supply for automatic startup.
VIN	5	Input Supply Pin. Must be locally bypassed.
OC	6	Adjustable Current Limit (Floating Available).

## ELECTRICAL CHARACTERISTICS (Note 3)

( $V_{IN}=V_{EN}=5V, T_A = 25^{\circ}C$ , unless otherwise noted.)

PARAMETER	CONDITIONS	MIN	TYP	MAX	UNIT
Operating Input Voltage		2.2		16	V
Under Voltage Lockout				2.2	V
Under Voltage Lockout Hysteresis			100		mV
Current (Shutdown)	$V_{EN} = 0V$		0.1	1	$\mu A$
Quiescent Current (PFM)	$V_{FB} = 0.7V$ , No switch		100	200	$\mu A$
Quiescent Current (PWM)	$V_{FB} = 0.5V$ , switch		1.6	2.2	mA
Switching Frequency			1.2		MHz
Maximum Duty Cycle	$V_{FB} = 0V$	90			%
EN Input High Voltage		1.5			V
EN Input Low Voltage				0.6	V
OVP with Output			20		V
FB Voltage		0.588	0.6	0.612	V
FB Input Bias Current	$V_{FB} = 0.6V$	-50	-10		nA
SW On Resistance			80	150	m $\Omega$
SW Current Limit	$V_{IN} = 5V$ , Duty cycle=50%, OC floating		2.5		A
Adjustable OCP Current	With External Resistor: 19k~96k	0.5		2.5	A
SW Leakage	$V_{SW} = 20V$			1	$\mu A$
Thermal Shutdown			160		$^{\circ}C$
Thermal Shutdown Hysteresis			25		$^{\circ}C$

**Note 1:** Absolute Maximum Ratings are those values beyond which the life of a device may be impaired.

**Note 2:**  $T_J$  is calculated from the ambient temperature  $T_A$  and power dissipation  $P_D$  according to the following formula:  $T_J = T_A + (P_D) \times (25^{\circ}C/W)$ .

**Note 3:** 100% production test at  $25^{\circ}C$ . Specifications over the temperature range are guaranteed by design and characterization.

## TYPICAL PERFORMANCE CHARACTERISTICS

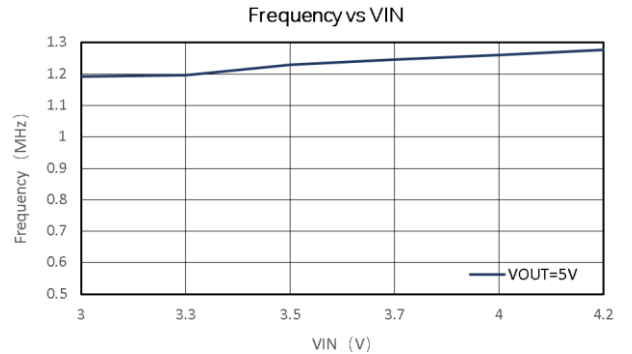
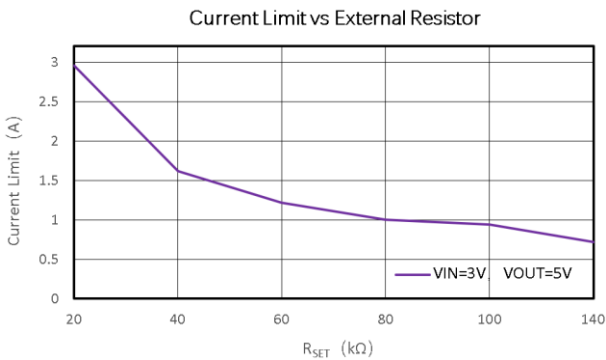
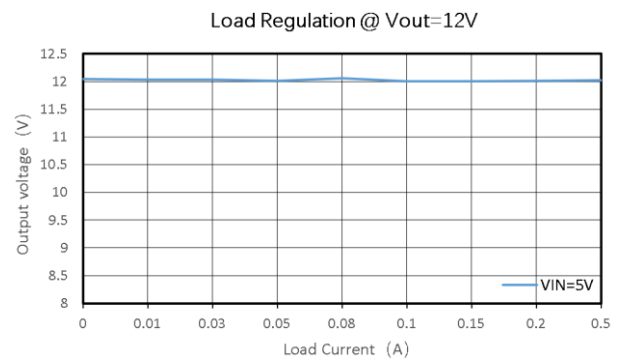
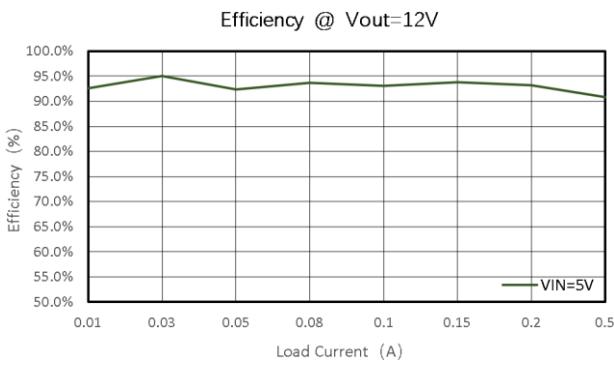
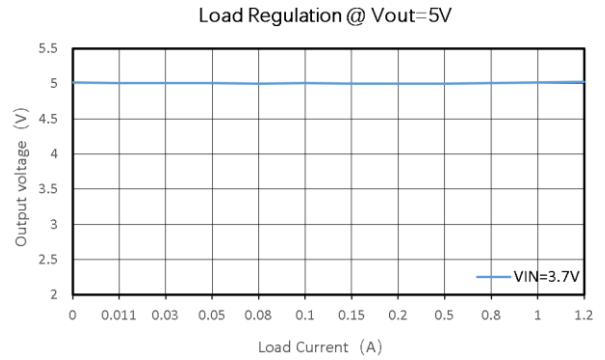
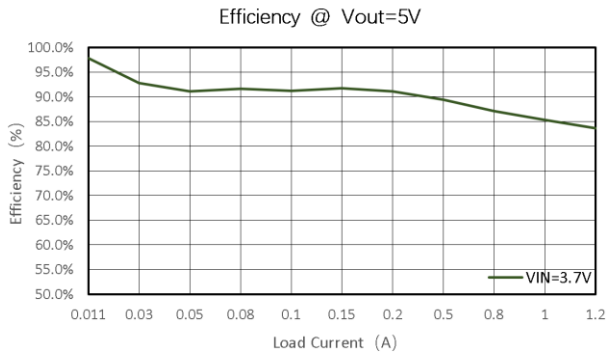

VIN=3.7V, VOUT=5V, ILOAD=0.5A

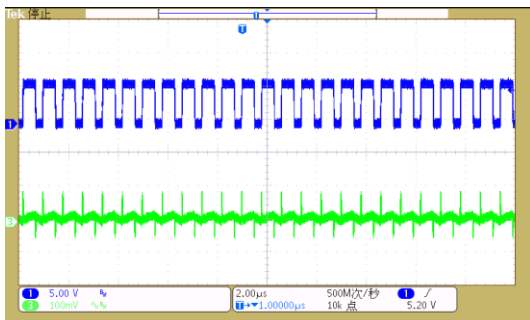

VIN=3.7V, VOUT=5V, ILOAD=1A

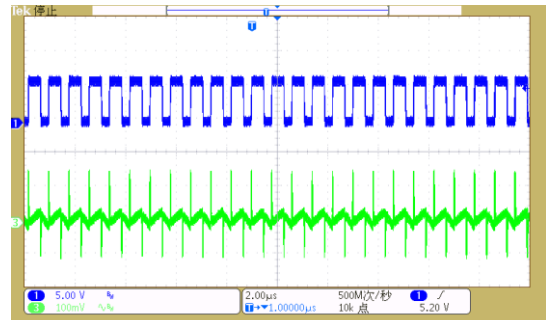

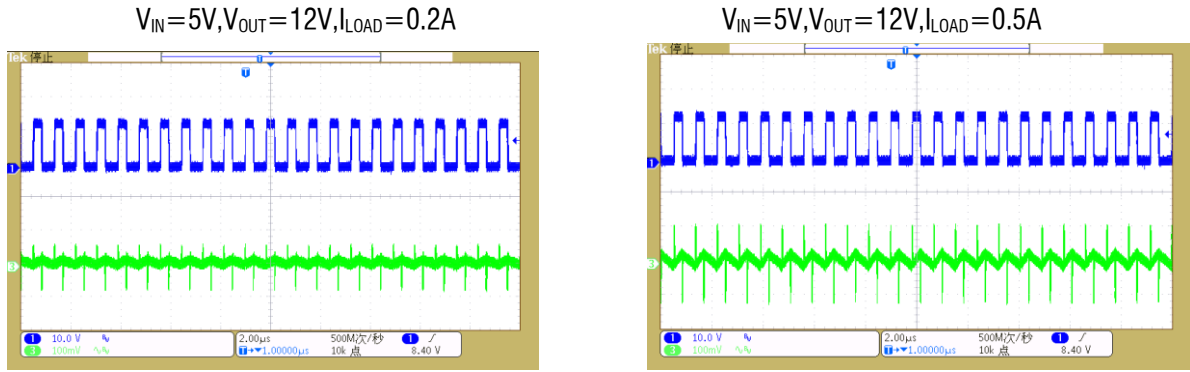

## FUNCTIONAL BLOCK DIAGRAM

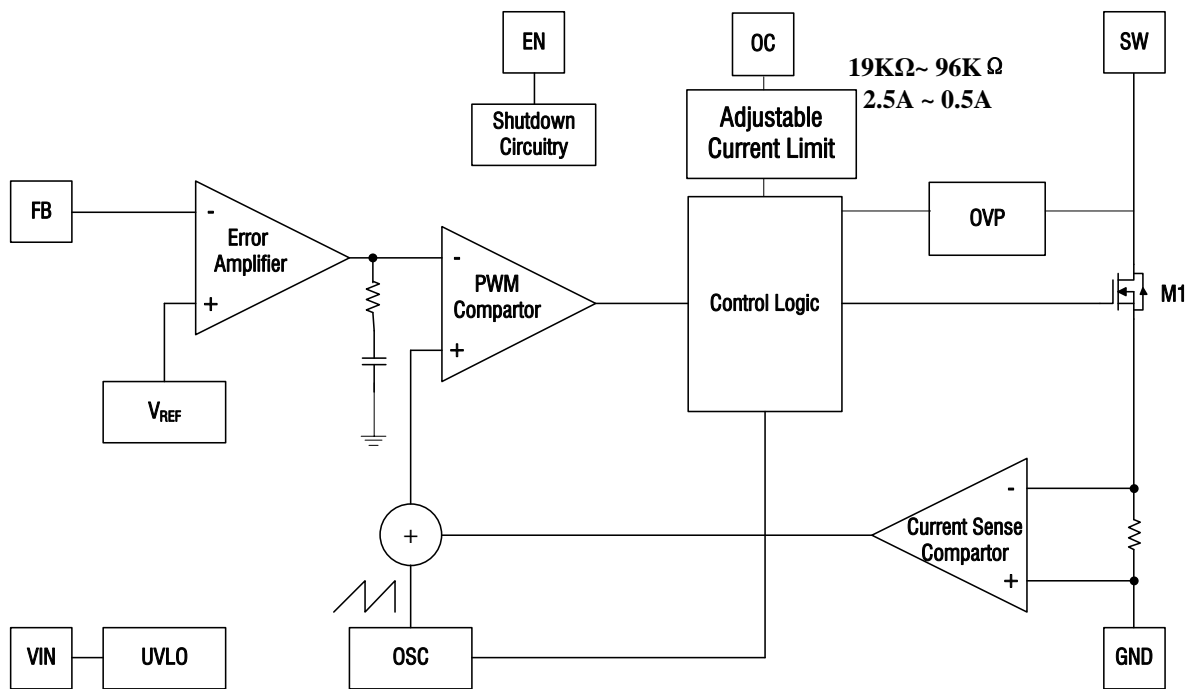

Figure 2. HL9710L Block Diagram

## FUNCTIONAL DESCRIPTION

### Overview

The HL9710L uses a fixed frequency, peak current mode boost regulator architecture to regulate voltage at the feedback pin. The operation of the HL9710L can be understood by referring to the block diagram of Figure 2. At the start of each oscillator cycle the MOSFET is turned on through the control circuitry. To prevent sub-harmonic oscillations at duty cycles greater than 50 percent, a stabilizing ramp is added to the output of the current sense amplifier and the result is fed into the negative input of the PWM comparator. When this voltage equals the output voltage of the error amplifier the power MOSFET is turned off. The voltage at the output of the error amplifier is an amplified version of the difference between the 0.6V bandgap reference voltage and the feedback voltage. In this way the peak current level keeps the output in regulation. If the feedback voltage starts to drop, the output of the error amplifier increases. These results in more current to flow through the power MOSFET, thus increasing the power delivered to the output. The

HL9710L has internal soft start to limit the amount of input current at startup and to also limit the amount of overshoot on the output.

### Current Limit Program

A resistor between OC and GND pin programs peak switch current. The resistor value should be between 19k and 96k. The current limit will be set from 2.5A to 0.5A. Keep traces at this pin as short as possible. The OC pin can be floating, the current limit will be set by Internal 2.5A current limit. To set the over current trip point according to the following equation:

$$I_{OC} = 48000/R3$$

### Over Voltage Protection (OVP)

In some condition, the resistive divider may be unconnected, which will cause PWM signal to operate with maximum duty cycle and output voltage is boosted higher and higher. The power MOSFET will be turned off immediately, when the output voltage exceeds the OVP threshold level. The HL9710L's OVP threshold is 20V.

## APPLICATIONS INFORMATION

### Setting the Output Voltage

The internal reference  $V_{REF}$  is 0.6V (Typical). The output voltage is divided by a resistor divider,  $R_1$  and  $R_2$  to the FB pin. The output voltage is given by

$$V_{OUT} = V_{REF} \times \left( 1 + \frac{R_1}{R_2} \right)$$

### Inductor Selection

The recommended values of inductor are 4.7 to 22 $\mu$ H. Small size and better efficiency are the major concerns for portable device, such as HL9710L used for mobile phone. The inductor should have low core loss at 1.2MHz and low

DCR for better efficiency. To avoid inductor saturation current rating should be considered.

### Capacitor Selection

Input and output ceramic capacitors of 22 $\mu$ F are recommended for HL9710L applications. For better voltage filtering, ceramic capacitors with low ESR are recommended. X5R and X7R types are suitable because of their wider voltage and temperature ranges.

### Diode Selection

Schottky diode is a good choice for HL9710L because of its low forward voltage drop and fast

reverses recovery. Using Schottky diode can get better efficiency. The high speed rectification is also a good characteristic of Schottky diode for high switching frequency. Current rating of the diode must meet the root mean square of the peak current and output average current multiplication as following

$$I_D(\text{RMS}) \approx \sqrt{I_{\text{OUT}} \times I_{\text{PEAK}}}$$

The diode's reverse breakdown voltage should be larger than the output voltage.

### Layout Consideration

For best performance of the HL9710L, the following guidelines must be strictly followed.

- Input and Output capacitors should be placed close to the IC and connected to ground plane to reduce noise coupling.
- The GND should be connected to a strong ground plane for heat sinking and noise protection.
- Keep the main current traces as possible as

short and wide.

- SW node of DC-DC converter is with high frequency voltage swing. It should be kept at a small area.
- Place the feedback components as close as possible to the IC and keep away from the noisy devices.

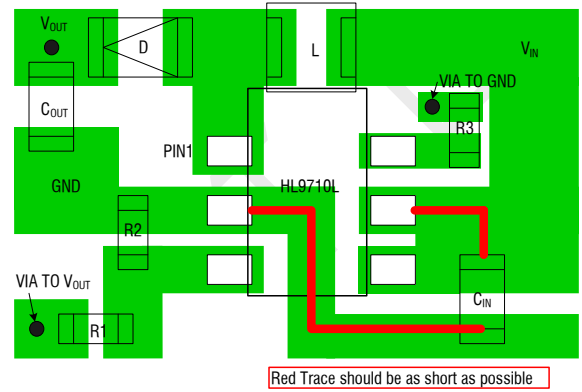
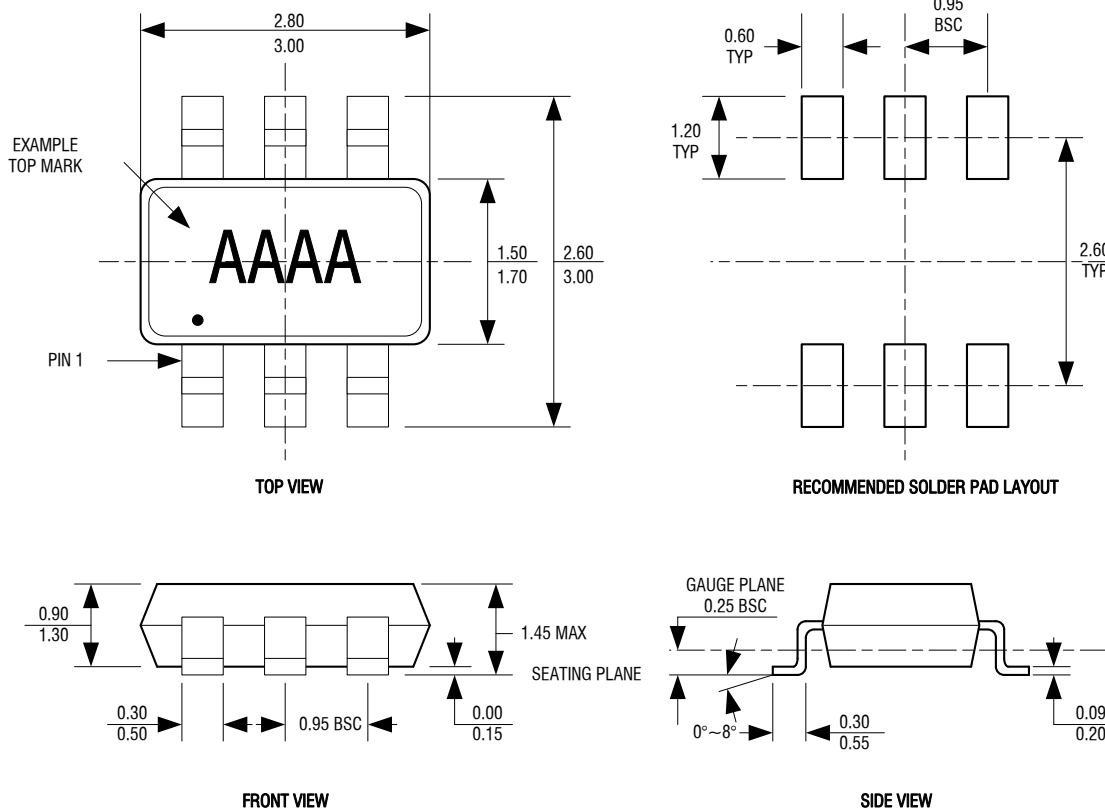

Figure 3. HL9710L Suggested Layout

## PACKAGE DESCRIPTION

### SOT23-6



- NOTE:**
1. DIMENSIONS ARE IN MILLIMETERS.
  2. DRAWING NOT TO SCALE.
  3. DIMENSIONS ARE INCLUSIVE OF PLATING.
  4. DIMENSIONS ARE EXCLUSIVE OF MOLD FLASH AND METAL BURR.