

Features

- Wide 4.5V to 55V Operating input Range
- 600mA Continuous Output Current
- 2MHz Switching Frequency
- Built-in Over Current Limit
- Internal Soft start
- 900mΩ Low RDS(ON) Internal Power MOSFETs
- Output Adjustable from 0.795V
- Integrated internal compensation
- Thermal Shutdown
- Short-circuit protection
- Available in SOT23-6, Package
- -40°C to +85°C Temperature Range

Applications

- Power Meters
- Distributed Power Systems
- Battery Chargers
- Pre-Regulator for Linear Regulators
- WLED Drivers

General Description

The HL8943 is a monolithic, step-down, switch mode converter with a built-in power MOSFET. Capable of delivering up to 600mA of output current over a wide input supply range with excellent load and line regulation. At light loads, the regulator operates in low frequency to maintain high efficiency and low output ripple. The minimum input voltage may be as low as 4.5V and the

maximum up to 55V, with even higher transient voltages. Fault condition protections include cycle-by-cycle current limiting and thermal shutdown.

The HL8943 requires a minimal number of readily-available external components. The HL8943 is available in a SOT23-6 package.

Typical Application

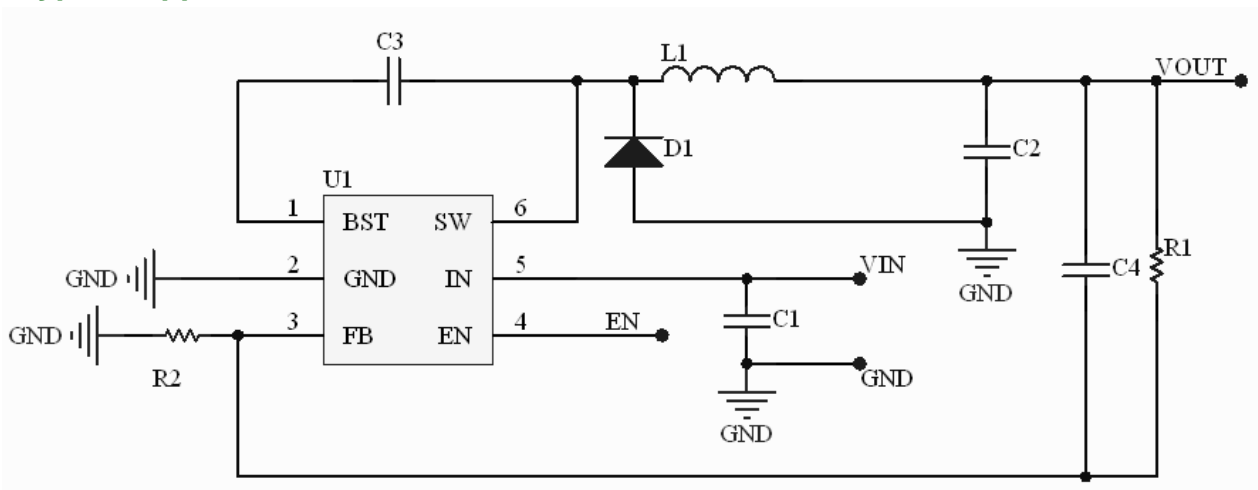

System Block Diagram

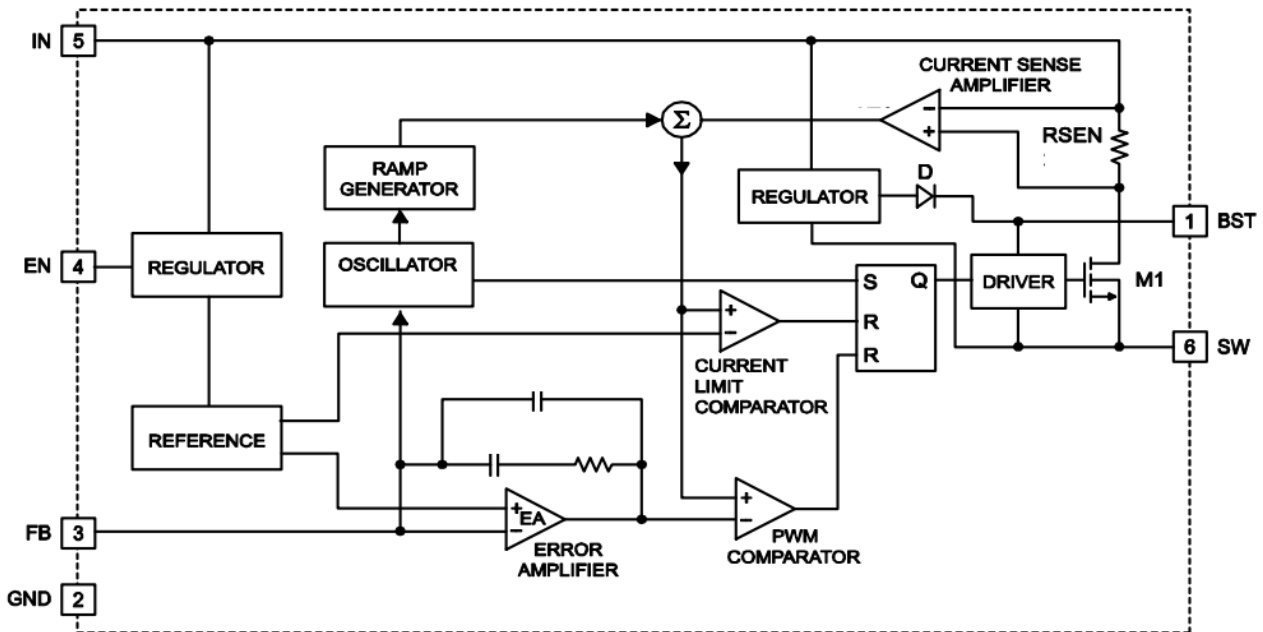

Functional Description

Internal Regulator

The HL8943 is a wide input range, DC-to-DC step-down switching regulator. This device contains an internal, low resistance, high voltage power MOSFET, and operates at a high operating frequency of 2M to ensure a compact,

Error Amplifier

The EA compares the FB pin voltage with the internal FB reference (VFB) and outputs a current proportional to the difference between the two. This output current is then used to charge or discharge the internal compensation

Under-Voltage Lockout (UVLO)

Under-voltage lockout (UVLO) protects the chip from operating at an insufficient supply voltage. UVLO protection monitors the internal regulator voltage. When

Thermal Shutdown

Thermal shutdown prevents the chip from operating at exceedingly high temperatures. When the silicon die temperature exceeds 160°C, it shuts down the whole chip.

high efficiency design with the use of small external components, such as ceramic input and output caps, as well as small inductors.

network to form the COMP voltage, which is used to control the power MOSFET current. The optimized internal compensation network minimizes the external component counts and simplifies the control loop design.

the voltage is lower than UVLO threshold voltage, the device is shut off. When the voltage is higher than UVLO threshold voltage, the device is enabled again.

When the temperature falls below its lower threshold (Typ. 130°C) the chip is enabled again.

Internal Soft-Start

The soft-start is implemented to prevent the converter output voltage from overshooting during startup. When the chip starts, the internal circuitry generates a soft-start voltage (SS). When it is lower than the internal reference

(REF), SS overrides REF so the error amplifier uses SS as the reference. When SS is higher than REF, REF regains control. The SS time is internally max to 900us.

PFM Mode

HL8943 operates in PFM mode at light load. In PFM mode, switch frequency decreases when load current drops to boost power efficiency at light load by reducing

switch-loss, while switch frequency increases when load current rises, minimizing output voltage ripples.

Startup and Shutdown

If both IN and EN are higher than their appropriate thresholds, the chip starts. The reference block starts first, generating stable reference voltage and currents, and then the internal regulator is enabled. The regulator provides stable supply for the remaining circuitries. Three events can shut down the chip: EN low, IN low and

thermal shutdown. In the shutdown procedure, the signaling path is first blocked to avoid any fault triggering. The COMP voltage and the internal supply rail are then pulled down. The floating driver is not subject to this shutdown command.

Pin Configuration

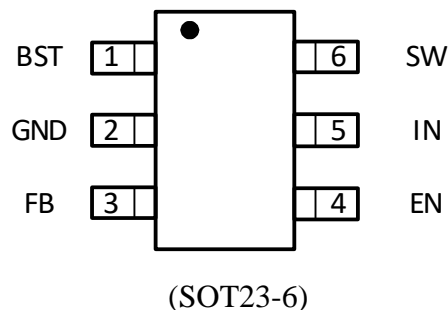

Pin Description

PIN	NAME	FUNCTION
1	BST	Bootstrap ,A capacitor connected between SW and BST pins is required to form a floating supply across the high-side switch driver.
2	GND	GROUND Pin
3	FB	Adjustable Version Feedback input. Connect FB to the center point of the external resistor divider
4	EN	Drive this pin to a logic-high to enable the IC. Drive to a logic-low to disable the IC and enter micro-power shutdown mode.



5	IN	Power Supply Pin
6	SW	Switching Pin

Absolute Maximum Ratings

V _{IN} , EN, Voltage	-0.3V to 55V	Storage Temperature Range.....	-55°C to 150°C
Operating Temperature Range	-40°C to +85°C	BS Voltage.....	(V _{sw} -0.3) to (V _{sw} +5V)
FB Voltages.....	-0.3 to 6V	Thermal Resistance (θ _{JA})	160 °C/W
Lead Temperature(Soldering, 10s)	+260°C	Thermal Resistance(θ _{JC}).....	130 °C/W
SW Voltage	-0.3V to (V _{IN} +0.5V)		

Note 1: Exceeding these ratings may damage the device.

Note 2: The device is not guaranteed to function outside of its operating conditions

Electrical Characteristics

V_{IN}=12V, T_A=25°C, unless otherwise specified.

Parameter	Test Conditions	Min	Typ.	Max	Unit
Input Voltage Range	---	4.5	---	55	V
Supply Current (Quiescent)	V _{EN} =3.0V	---	---	2	mA
Supply Current (Shutdown)	V _{EN} =0 or EN = GND	---	---	4	uA
Feedback Voltage	---	---	0.795	---	V
Switch On-Resistance	---		900		mΩ
Upper Switch Current Limit	---	---	0.95	---	A
Switching Frequency	---	---	2	---	MHz
Maximum Duty Cycle	V _{FB} =90%	---	98	---	%
Minimum On-Time			100		nS
EN Rising Threshold		1.5	---	---	V
EN Falling Threshold		---	---	0.6	V
Under-Voltage Lockout Threshold	Wake up V _{IN} Voltage	---	---	4.8	V
	Shutdown V _{IN} Voltage	3.5	---	---	V
Soft Start		---	0.85	---	mS
Thermal Shutdown			160		°C
Thermal Hysteresis			30		°C

Note (1): MOSFET on-resistance specifications are guaranteed by correlation to wafer level measurements.

Note (2): Thermal shutdown specifications are guaranteed by correlation to the design and characteristics analysis.

Typical Performance Characteristics

Note (1): Performance waveforms are tested on the evaluation board.

Note (2): C1=C2=22 μ F+0.1 μ F, C3=0.1 μ F, C4=33pF, L=47 μ H, D=SS16

VIN =12V, VOUT=3.3V, TA = +25°C, unless otherwise noted.

(1) Quiescent Current VS Input Voltage

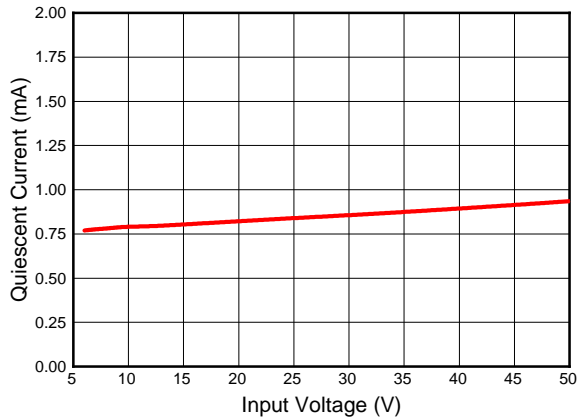

(2) Feedback Voltage VS Input Voltage

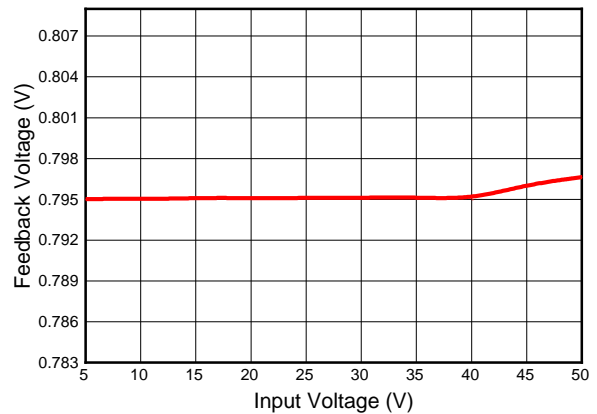

(3) Output Voltage VS Output Current (VOUT=3.3V)

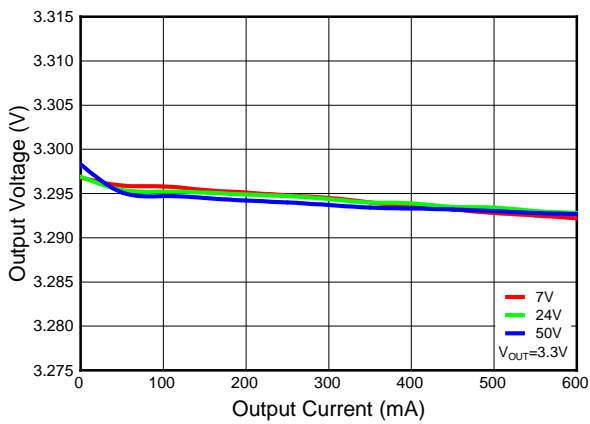

(4) Output Voltage VS Output Current (VOUT=12V)

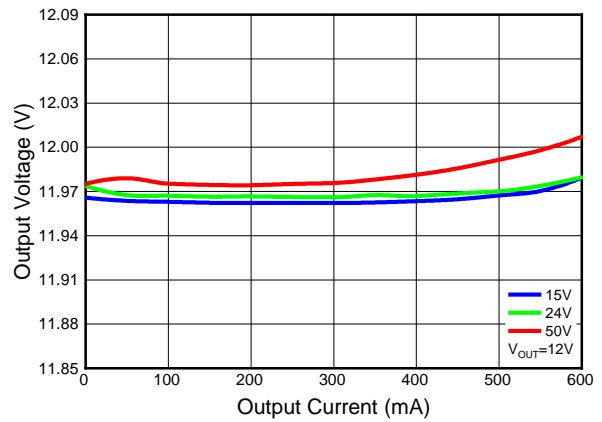

(5) Output Voltage VS Input Voltage (VOUT=3.3V)

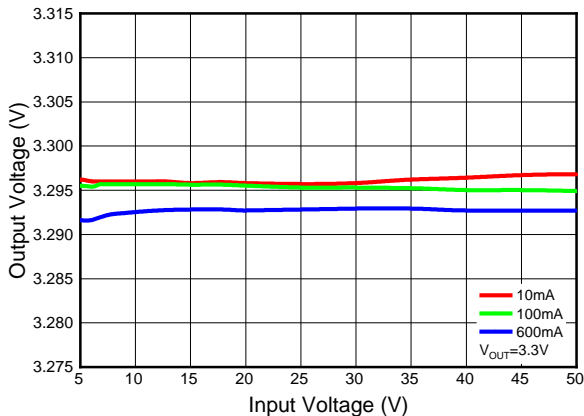

(6) Output Voltage VS Input Voltage (VOUT=12V)

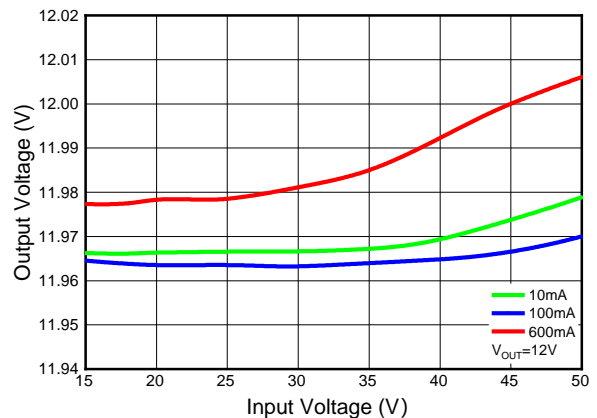

(7) Efficiency VS Output Current ($V_{OUT}=3.3V$)

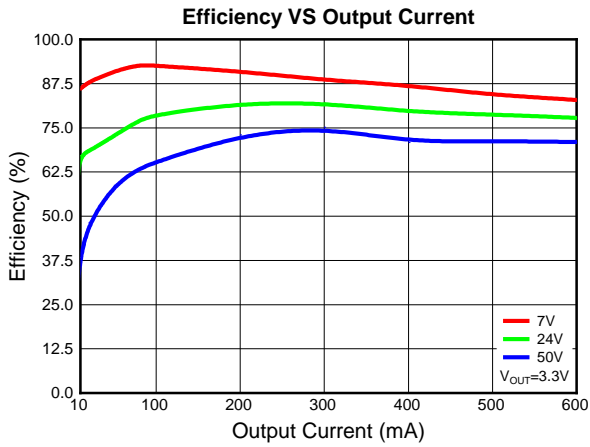

(8) Efficiency VS Output Current ($V_{OUT}=12V$)

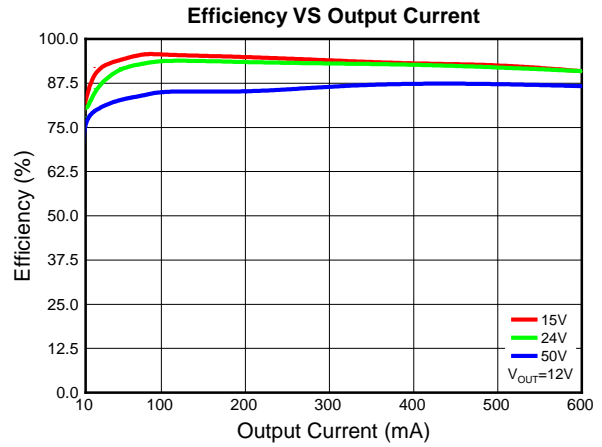

(9) Efficiency VS Input Voltage ($V_{OUT}=3.3V$)

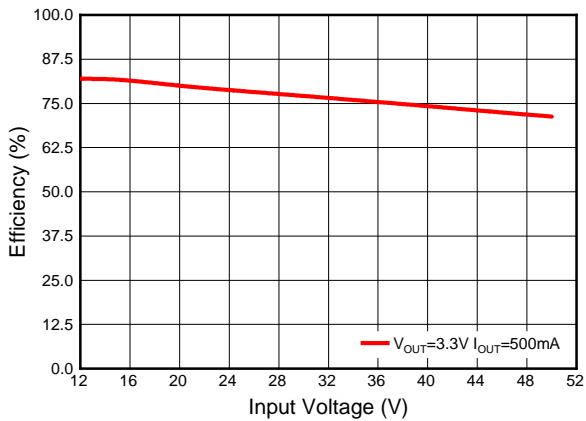

(10) Efficiency VS Input Voltage ($V_{OUT}=12V$)

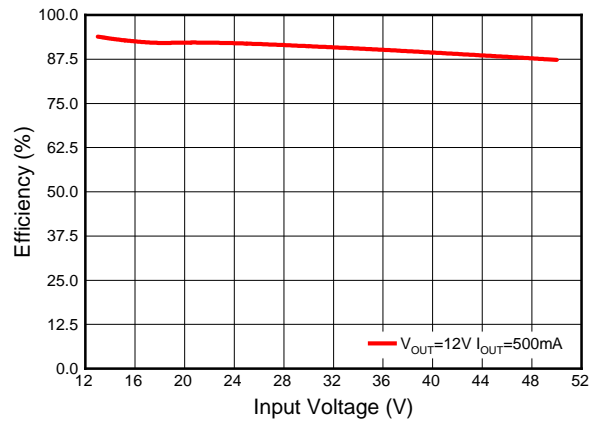

(11) Quiescent Current VS Temperature

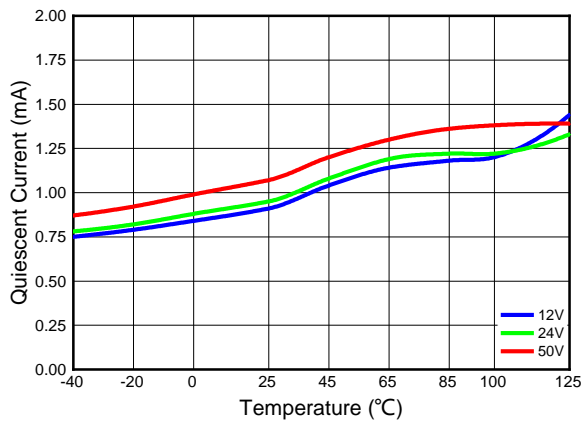

(12) Feedback Voltage VS Temperature

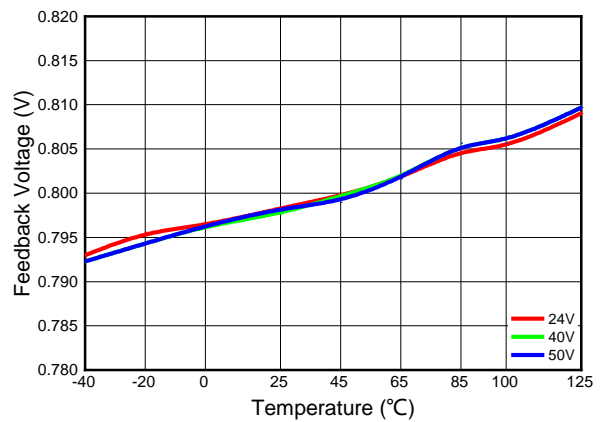

(13) Output Ripple (VIN=50.0V,VOUT=3.3V,IOUT=0.6A)

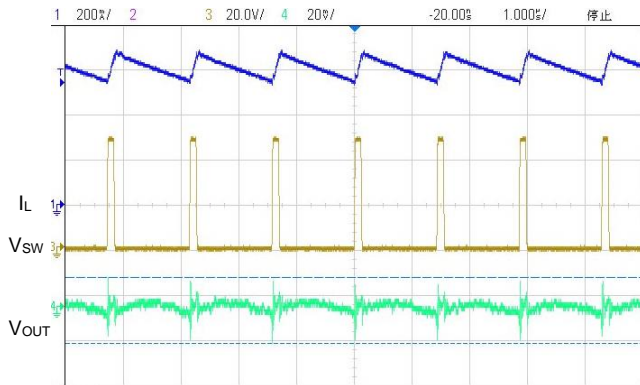

(14) Output Ripple (VIN=50.0V,VOUT=12V,IOUT=0.6A)

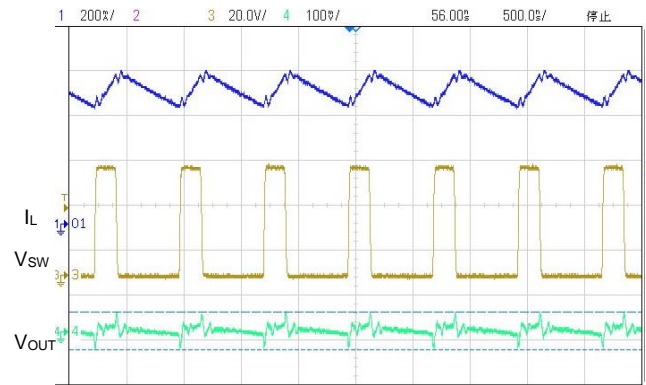

(15) Load Transient (VIN=50.0V,VOUT=3.3V,IOUT=0.1→0.6A)

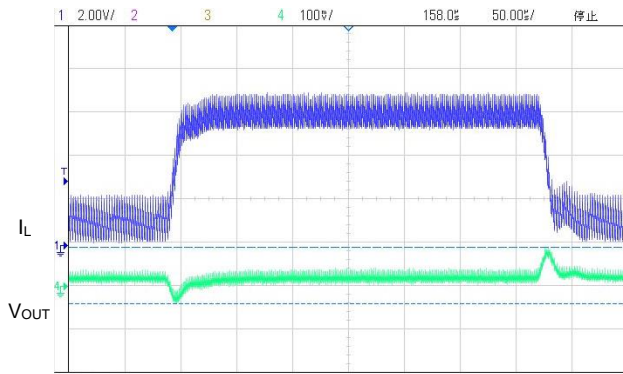

(16) Load Transient(VIN=50.0V,VOUT=12V,IOUT=0.1→0.6A)

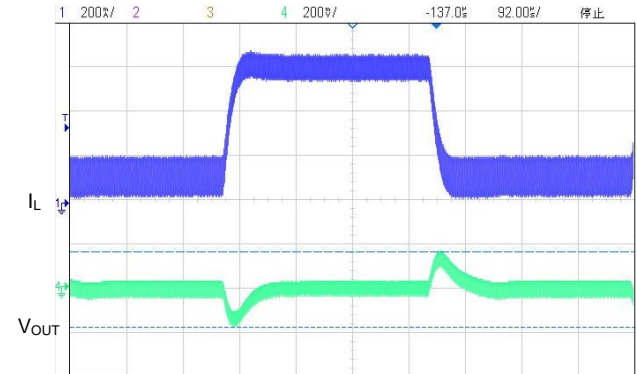

(17) Enable Start Up (VIN=30.0V,VOUT=3.3V,IOUT=0.6A)

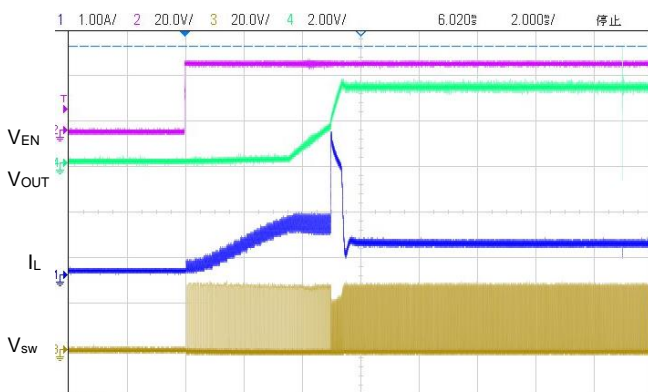

(18) Enable Shutdown(VIN=30.0V,VOUT=3.3V,IOUT=0.6A)

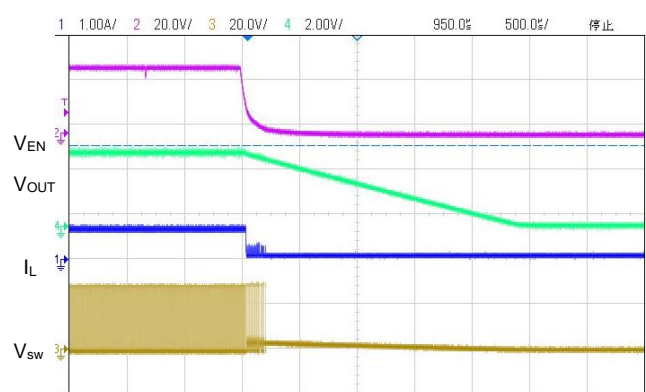

(19) Power Ramp Up (VIN=50.0V, VOUT=3.3V, IOUT=0.6A)

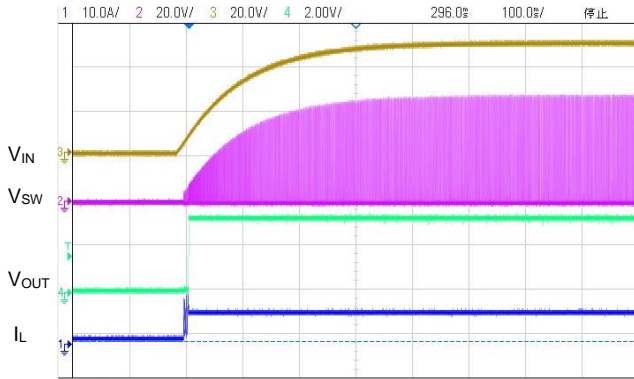

(20) Power Ramp Down (VIN=50.0V, VOUT=3.3V, IOUT=0.6A)

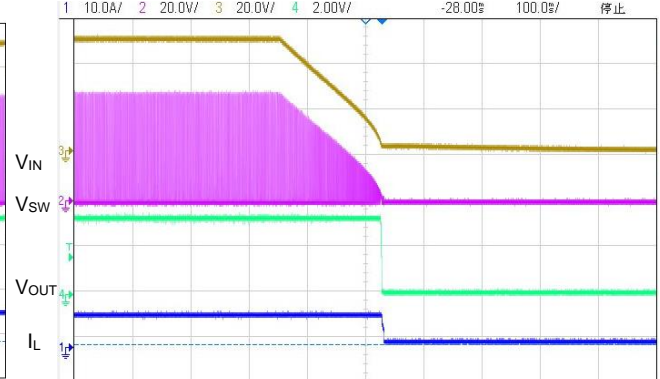

(21) Short Output (VIN=50.0V, VOUT=12V, IOUT=0.6A)

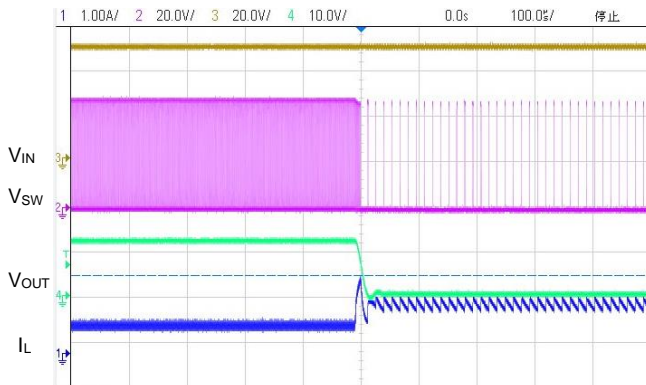

(22) Short Output Recovery (VIN=50.0V, OUT=12V, IOUT=0.6A)

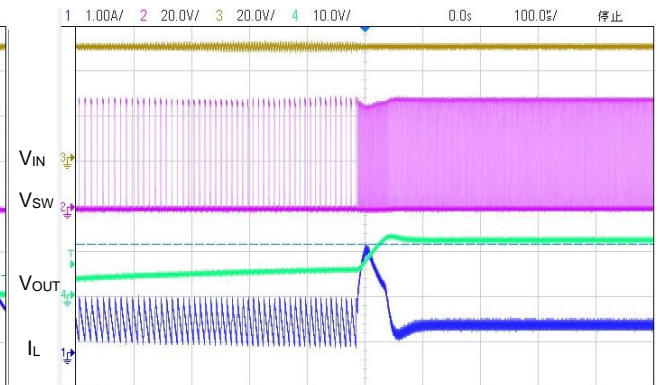

(23) Steady State (VIN=20.0V, VOUT=12V, IOUT=0.6A)

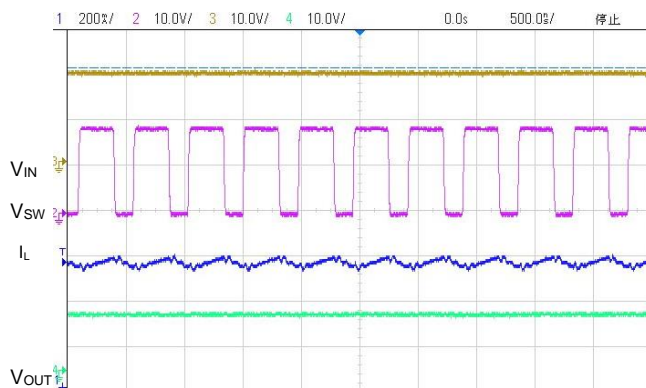

(24) Steady State (VIN=50.0V, VOUT=12V, IOUT=0.6A)

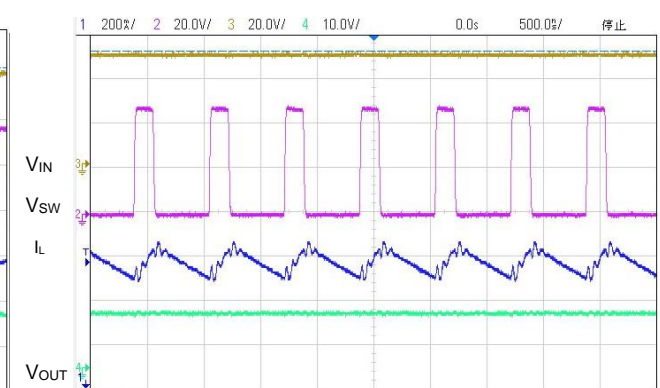

Applications Information

Setting the Output Voltage

HL8943 require an input capacitor, an output capacitor and an inductor. These components are critical to the performance of the device. HL8943 are internally compensated and do not require external components to achieve stable operation. The output voltage can be programmed by resistor divider.

$$V_{OUT} = V_{FB} \times \frac{R1 + R2}{R2}$$

V _{OUT} (V)	R1(KΩ)	R2(KΩ)	L1(μH)	C1(μF)	C2(μF)	C3(μF)	C4(pF)
3.3	39	12.5	6.8~47	22+0.1	22+0.1	0.1	33
5.0	47	8.9	6.8~47	22+0.1	22+0.1	0.1	33
12	127.4	9.1	15~47	22+0.1	22+0.1	0.1	33

All the external components are the suggested values, the final values are based on the application testing results.

Selecting the Inductor

The recommended inductor values are shown in the Application Diagram. It is important to guarantee the inductor core does not saturate during any foreseeable operational situation. The inductor should be rated to handle the maximum inductor peak current: Care should be taken when reviewing the different saturation current ratings that are specified by different manufacturers. Saturation current ratings are typically specified at 25 °C, so ratings at maximum ambient temperature of the application should be requested from the manufacturer. The inductor value can be calculated with:

$$L = \frac{V_{OUT} \times (V_{IN} - V_{OUT})}{V_{IN} \times \Delta I_L \times F_{OSC}}$$

Where ΔI_L is the inductor ripple current. Choose inductor ripple current to be approximately 30% to 40% of the maximum load current. The maximum inductor peak current can be estimated as:

$$I_{L(MAX)} = I_{LOAD} + \frac{\Delta I_L}{2}$$

Under light load conditions below 100mA, larger inductance is recommended for improved efficiency. Larger inductances lead to smaller ripple currents and voltages, but they also have larger physical dimensions, lower saturation currents and higher linear impedance. Therefore, the choice of inductance should be compromised according to the specific application.

Selecting the Input Capacitor

The input current to the step-down converter is discontinuous and therefore requires a capacitor to supply AC current to the step-down converter while maintaining the DC input voltage. For a better performance, use ceramic capacitors placed as close to VIN as possible and a 0.1μF input capacitor to filter out high frequency interference is recommended. Capacitors with X5R and X7R ceramic dielectrics are recommended because they are stable with temperature fluctuations.

The capacitors must also have a ripple current rating greater than the maximum input ripple current of the converter. The input ripple current can be estimated with Equation:

$$I_{CIN} = I_{OUT} \times \sqrt{\frac{V_{OUT}}{V_{IN}} \times \left(1 - \frac{V_{OUT}}{V_{IN}}\right)}$$

From the above equation, it can be concluded that the input ripple current reaches its maximum at $V_{IN}=2V_{OUT}$ where

$I_{CIN} = \frac{I_{OUT}}{2}$. For simplification, choose an input capacitor with an RMS current rating greater than half of the maximum load current.

The input capacitance value determines the input voltage ripple of the converter. If there is an input voltage ripple requirement in the system, choose the input capacitor that meets the specification. The input voltage ripple can be estimate with Equation:

$$\Delta V_{IN} = \frac{I_{OUT}}{F_{OSC} \times C_{IN}} \times \frac{V_{OUT}}{V_{IN}} \times \left(1 - \frac{V_{OUT}}{V_{IN}}\right)$$

Similarly, when $V_{IN}=2V_{OUT}$, input voltage ripple reaches its maximum of $\Delta V_{IN} = \frac{1}{4} \times \frac{I_{OUT}}{F_{OSC} \times C_{IN}}$.

Selecting the Output Capacitor

An output capacitor is required to maintain the DC output voltage. The output voltage ripple can be estimated with Equation:

$$\Delta V_{OUT} = \frac{V_{OUT}}{F_{OSC} \times L} \times \left(1 - \frac{V_{OUT}}{V_{IN}}\right) \times \left(R_{ESR} + \frac{1}{8 \times F_{OSC} \times C_{OUT}}\right)$$

There are some differences between different types of capacitors. In the case of ceramic capacitors, the impedance at the switching frequency is dominated by the capacitance. The output voltage ripple is mainly caused by the capacitance. For simplification, the output voltage ripple can be estimated with Equation:

$$\Delta V_{OUT} = \frac{V_{OUT}}{8 \times F_{OSC}^2 \times L \times C_{OUT}} \times \left(1 - \frac{V_{OUT}}{V_{IN}}\right)$$

A larger output capacitor can achieve a better load transient response, but the maximum output capacitor limitation should also be considered in the design application. If the output capacitor value is too high, the output voltage will not be able to reach the design value during the soft-start time and will fail to regulate. The maximum output capacitor value (C_{OUT_MAX}) can be limited approximately with Equation:

$$C_{OUT_MAX} = (I_{LIM_AVG} - I_{OUT}) \times T_{SS} / V_{OUT}$$

Where I_{LIM_AVG} is the average start-up current during the soft-start period, and T_{SS} is the soft- start time.

On the other hand, special attention should be paid when selecting these components. The DC bias of these capacitors can result in a capacitance value that falls below the minimum value given in the recommended capacitor specifications table. The ceramic capacitor's actual capacitance can vary with temperature. The capacitor type X7R, which operates over a temperature range of -55°C to $+125^{\circ}\text{C}$, will only vary the capacitance to within $\pm 15\%$. The capacitor type X5R has a similar tolerance over a reduced temperature range of -55°C to $+85^{\circ}\text{C}$. Many large value ceramic capacitors, larger than

1uF are manufactured with Z5U or Y5V temperature characteristics. Their capacitance can drop by more than 50% as the temperature varies from 25°C to 85°C. Therefore, X5R or X7R is recommended over Z5U and Y5V in applications where the ambient temperature will change significantly above or below 25°C.

Feed-Forward Capacitor (C_{FF})

HL8943 has internal loop compensation, so adding C_{FF} is optional. Specifically, for specific applications, if necessary, consider whether to add feed-forward capacitors according to the situation.

The use of a feed-forward capacitor (C_{FF}) in the feedback network is to improve the transient response or higher phase margin. For optimizing the feed-forward capacitor, knowing the cross frequency is the first thing. The cross frequency (or the converter bandwidth) can be determined by using a network analyzer. When getting the cross frequency with no feed-forward capacitor identified, the value of feed-forward capacitor (C_{FF}) can be calculated with the following Equation:

$$C_{FF} = \frac{1}{2\pi \times F_{CROSS}} \times \sqrt{\frac{1}{R1} \times \left(\frac{1}{R1} + \frac{1}{R2}\right)}$$

Where F_{CROSS} is the cross frequency.

To reduce transient ripple, the feed-forward capacitor value can be increased to push the cross frequency to higher region. Although this can improve transient response, it also decreases phase margin and cause more ringing. In the other hand, if more phase margin is desired, the feed-forward capacitor value can be decreased to push the cross frequency to lower region.

Package Description

6-pin SOT23-6 Outline Dimensions

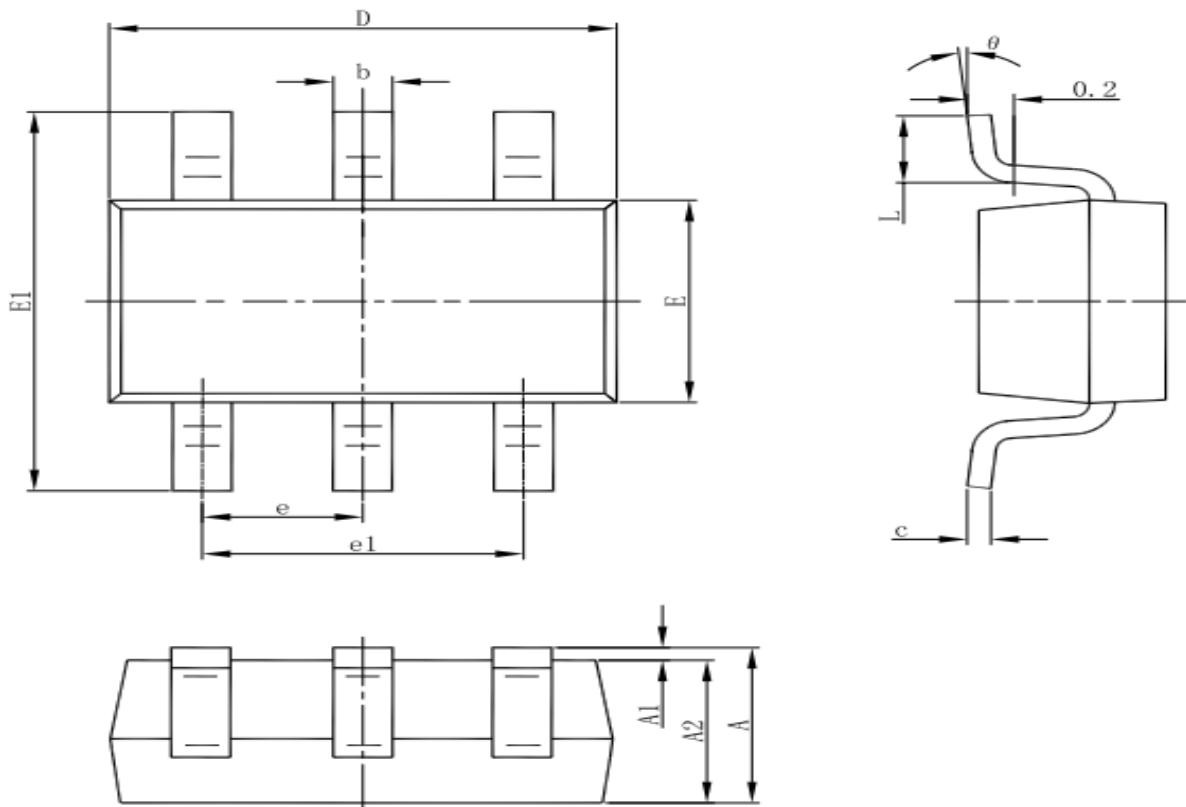

Symbol	Dimensions In Millimeters		Dimensions In Inches	
	Min	Max	Min	Max
A	1.050	1.250	0.041	0.049
A1	0.000	0.100	0.000	0.004
A2	1.050	1.150	0.041	0.045
b	0.300	0.500	0.012	0.020
c	0.100	0.200	0.004	0.008
D	2.820	3.020	0.111	0.119
E	1.500	1.700	0.059	0.067
E1	2.650	2.950	0.104	0.116
e	0.950(BSC)		0.037(BSC)	
e1	1.800	2.000	0.071	0.079
L	0.300	0.600	0.012	0.024
theta	0°	8°	0°	8°